

# User manual I-DE

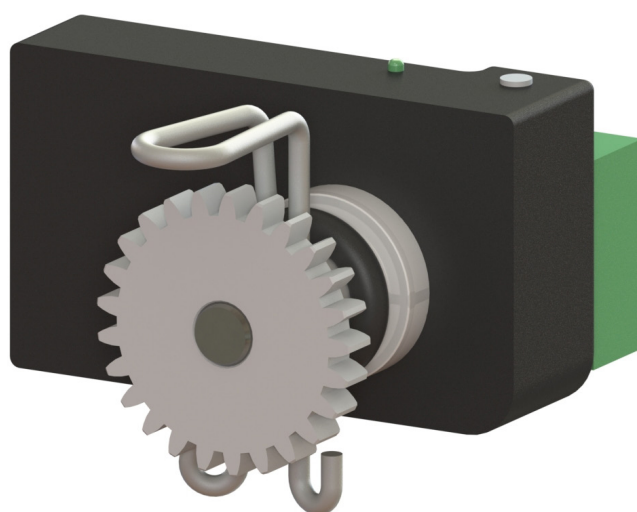

# Content

Quickstart.....	3
Introduction and summary.....	4
2 Wiring Diagram.....	5
3 Operation.....	7
4 Technical Specifications.....	16

## I-DE installation example

The I-DE is equipped with a O-ring, which ensures that it is properly secured in the motor gearbox housing.

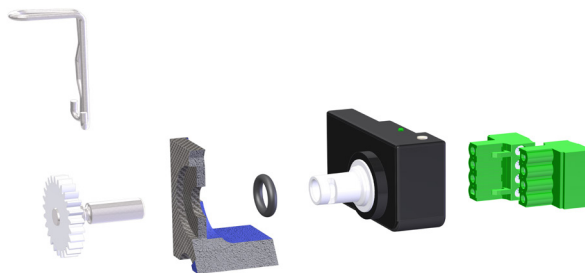















Figure 1 - I-DE

# Quickstart

The calibrated I-DE outputs: 4 mA when the motor gearbox is at minimum position, 20 mA when the motor gearbox is at maximum position. The 16 mA is distributed proportionally across the full stroke of the inlet valves. When a resistance of 500  $\Omega$  is applied, the output is 2 - 10 V.

If 0-10 V is needed, the current range must be switched from 4 - 20 mA to 0 - 20 mA. See section 3.5.3.

Symbol	Description of LED on the I-DE
	LED off
	LED lit continuously
	LED flashing (slowly)
	LED flashing (quickly)

Step	Action	Aim	LED colour/pattern during action	LED colour/pattern after action
1	Push and hold the button for 10 seconds. (wait until the LED lights up red)	Reset to factory settings		
2	Push and hold the button for 4 seconds. (wait until the red, quick-flashing LED has stopped again)	Activate the I-DE's calibration mode		
3	Place motor gearbox in start position	Determine minimum start position (inlet valves)		
4	Push and hold the button for 2 seconds. (wait until the LED starts flashing red quickly)	Calibrate minimum start position (inlet valves)		
5	Place motor gearbox in end position	Determine maximum end position (inlet valves)		
6	Push and hold the button for 2 seconds. (wait until the LED starts flashing red quickly)	Calibrate maximum end position (inlet valves)		
7	Push and hold the button for 4 seconds. (wait until the LED stops flashing red quickly)	Place I-DE in operating mode: ready		

\* if in doubt, or if something is wrong, start again at step 1



# Introduction and summary

## Introduction

The I-DE is a multifunctional position sensor. It is important that the I-DE is connected and used correctly. This user manual discusses various components in great depth. It explains how the I-DE should be fully connected, used and calibrated.

## Summary

The I-DE can be operated easily using a push button. The current status of the I-DE is indicated by various LED flash patterns.

The stroke of the motor gearbox can be calibrated in the I-DE. Using an analogue current signal, the I-DE is able to report the position of the motor gearbox back to the process computer or control box. The I-DE also features a digital output. When the motor gearbox rotates, the I-DE outputs digital A/B/Z signals. The position and motion of the motor gearbox can be monitored easily using the I-DE.

To make all of the above functions possible, the I-DE has a large number of connection points. Figure 2 shows a diagram of the I-DE. Table 1 then lists the eight connection points on the I-DE.

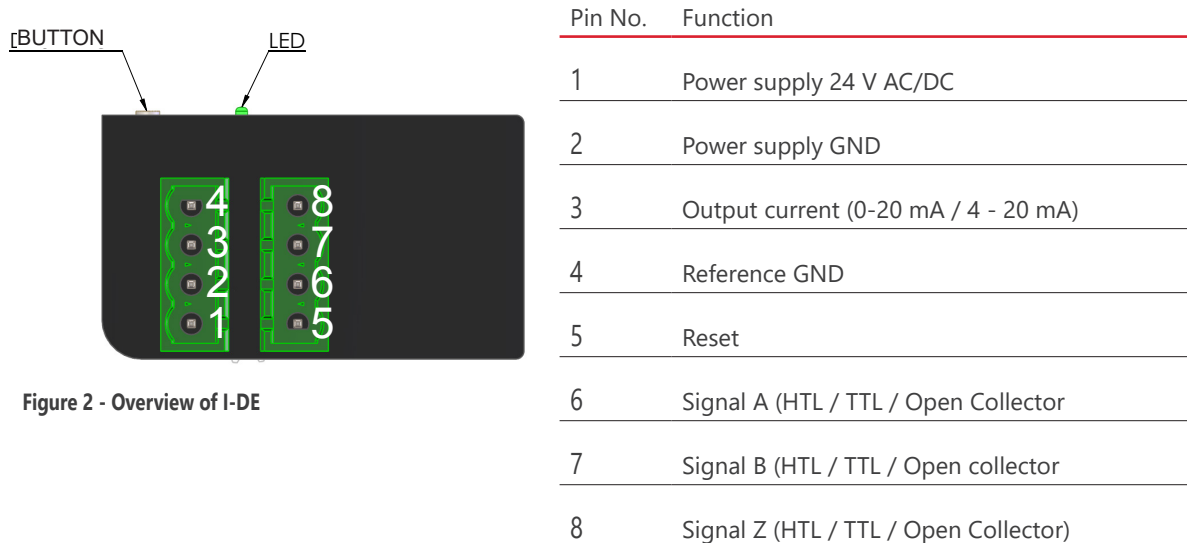

Figure 2 - Overview of I-DE

## 2 Wiring Diagram

For the proper functioning of the I-DE it is important that it is connected correctly. The connection of the power supply, current output, A/B/Z output and reset input are discussed in this chapter.

### 2.1 Power supply

The I-DE has to be connected to the power supply as indicated in figure 3. Both a DC- or AC- 24V signal can be connected to the power inlet.

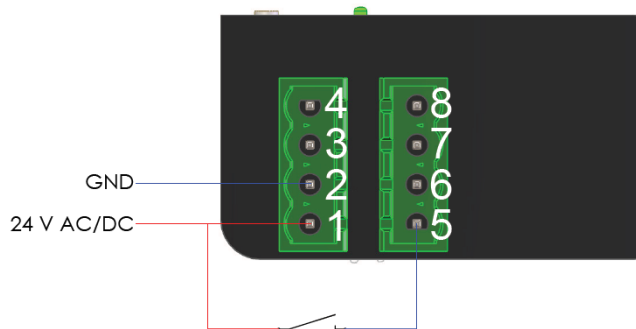

Figure 3 - Wiring diagram power supply and reset input

### 2.2 Reset input

The reset input has to be connected. This can be done by means of an external signal or by means of one of the limit switches, as long as this limit switch is powered by the same power supply as the I-DE. See figure 3 for the wiring diagram. For limit switch 1 use connections 8 and 9 on the limit switch terminal block. If you want to use limit switch 2 as a reset signal you have to use connections 2 and 3 on the limit switch terminal block. The 24V AC/DC supply has to be wired to connections 3 and 9 of the limit switch terminal block. For more information we refer you to the manual for the GW motor gearbox. Should you have a different power supply to the limit switch then an additional relay (P.IDE,RST,230.01) can be used to generate a signal for the reset input.

#### Note!

Connection of a 230V AC supply to any of the terminals of the I-DE is not permitted.

## 2 Wiring Diagram

### 2.3 Current output

The current output of the I-DE can be used as shown in the wiring diagram in figure 4. As should be clear from figure 4 it is absolutely not permitted to connect an additional (external) power supply to the current output.

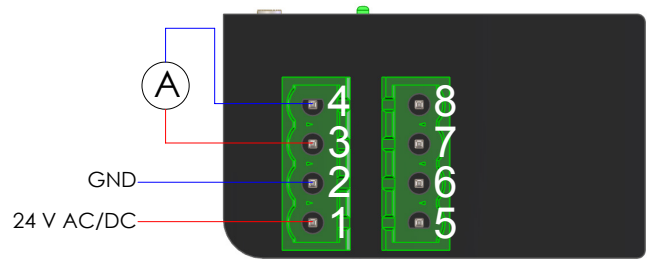

Figuur 4 - Current output wiring diagram

### 2.4 A/B/Z outputs

If "HTL" or "TTL" is selected for the A/B/Z outputs, then the wiring diagram in figure 5 should be used.

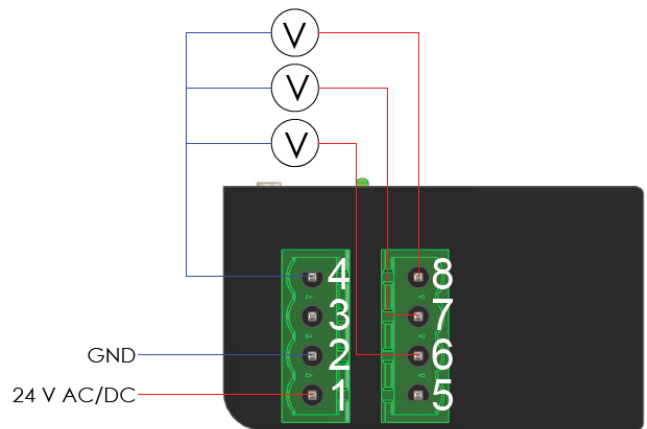

Figuur 5 - Wiring diagram A/B/Z outputs HTL or TTL

If "Open Collector" is selected for the A/B/Z outputs, then the wiring diagram in figure 5 should be supplemented with the wiring diagram in Figure 6.

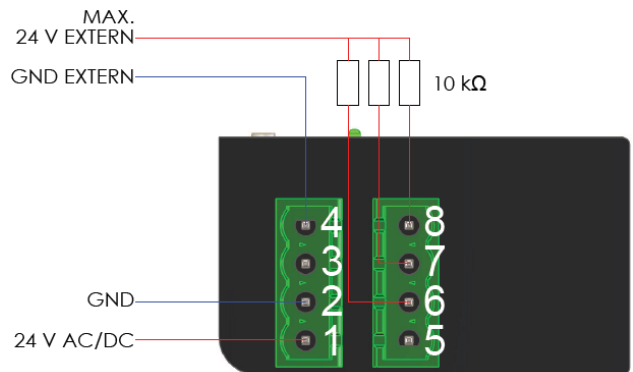

Figuur 6 - Wiring diagram reset input A/B/Z uitgang Open Collector

# 3 Operation

Various LED (flash) patterns are used as a means to distinguish between the different statuses of the I-DE. All of the statuses will be discussed in this section, including the corresponding flash patterns.

## 3.1 LED flash patterns

### Normal operation

---



Constant red / green light.

### Error mode

---



Repeatedly flashing red / green / orange.



Alternately flashing red and green.

### Calibration mode

---



Repeatedly flashing red / green / orange once.  
The LED will flash in the specified colour once and then go off for a short period of time.



Repeatedly flashing red / green / orange twice.  
The LED will flash in the specified colour twice and then go off for a short period of time.



Repeatedly flashing red / green / orange three times.  
The LED will flash in the specified colour three times and then go off for a short period of time.



Repeatedly flashing red / green / orange four times.  
The LED will flash in the specified colour four times and then go off for a short period of time.



Repeatedly flashing red / green / orange five times.  
The LED will flash in the specified colour five times and then go off for a short period of time.



### Confirming a selection

---



Flashing red repeatedly very quickly.

---

# 3 Operation

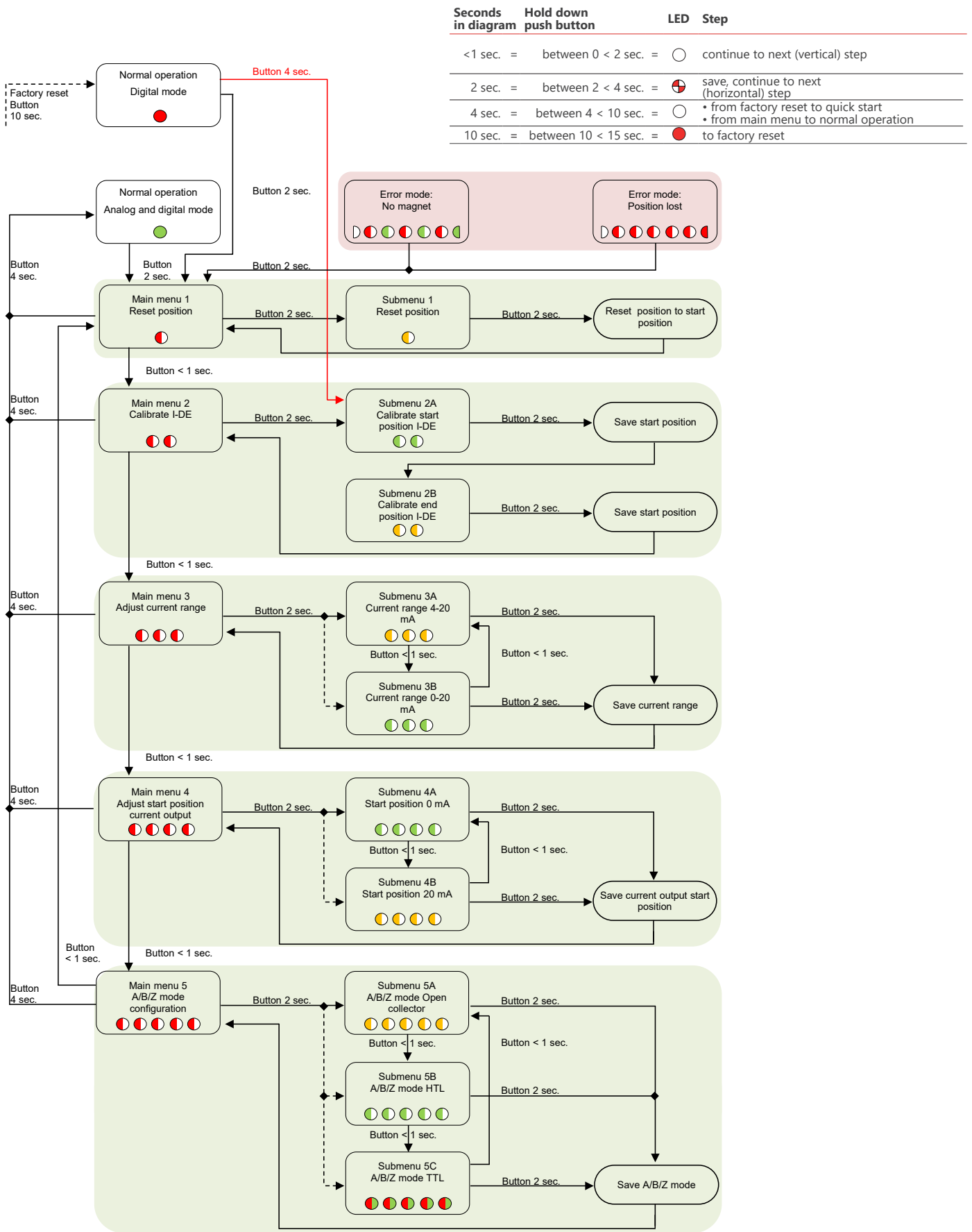

Figure 7 - I-DE flow diagram





# 3 Operation

## 3.2 I-DE flow diagram

Figure 7 shows a flow diagram of the I-DE. This diagram employs the symbols described for the LED and distinguishes between the different push button actions.

**NOTE!**



The LED pattern displayed in response to each "two second action" on the push button.

### Situations during normal operation



The I-DE has **not** been calibrated and can be used as a digital encoder.



The I-DE has been calibrated and can be used as both a digital and analogue encoder.

## 3.3.1 Output current

Depending on the settings and position of the motor gearbox, the I-DE will (when calibrated) output a current of between '0 and 20 mA', or '4 and 20 mA'.

## 3.3.2 A/B/Z outputs

The A/B/Z outputs of the I-DE will be activated during the rotation of the motor gearbox (7-bit precision). The outputs can be configured in three different ways:

1. Open Collector.
2. HTL: A signal of 0V or 24 V ( $\pm 2$  V) is output at the A/B/Z outputs.
3. TTL: A signal of 0V or 5 V ( $\pm 0.5$  V) is output at the A/B/Z outputs.

To change the A/B/Z configuration, see the paragraph entitled "I-DE A/B/Z mode configuration" in this section.

Figure 8 shows how the A, B and Z signal are rendered with the 7-bit resolution of the magnetic sensor when the motor gearbox is running. The Z-signal is activated once per revolution.

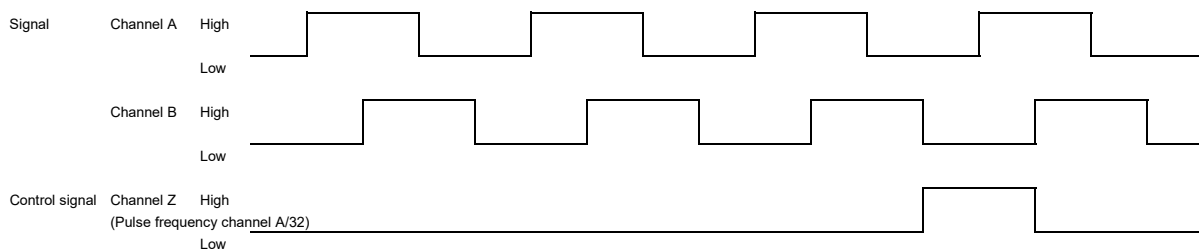

Figure 8 - Explanation of A/B/Z/ signals

# 3 Operation

## 3.4 Error mode

### Situations in Error mode



The I-DE has lost its position. Reset the I-DE to its reference position.

Automatically:

Allow the motor gearbox to turn to the reset (limit) switch in order to reset the I-DE. The I-DE will output the correct signal from the moment that it is reset.

Manually:

Allow the motor gearbox to turn to the reference position, where the starting point of the I-DE was calibrated. Reset the I-DE via main menu 1, see section 3.5.1



The I-DE is not detecting a magnetic field.

- Disconnect the I-DE from the power supply.
- Check: the installation of the I-DE in the motor gearbox; the mounting spring that positions the I-DE inside the motor gearbox housing; whether the shaft is properly positioned in the I-DE; whether the magnet in the shaft is properly secured in position. Make adjustments where necessary.
- After correction, the power can be restored to the I-DE and the I-DE should function correctly.

## 3.5 Calibration mode

The I-DE can be calibrated via the main menu. The main menu can be accessed from "Normal operation" or from "Error mode".

The main menu comprises the following elements:

- Reset I-DE position
- Calibrate I-DE
- Adjust I-DE current range
- Set I-DE current output start position
- I-DE A/B/Z mode configuration

### Access the main menu



When in "Normal operation" or "Error mode", push and hold the button for two seconds, then release. After 2 seconds, this LED pattern will be displayed.



The LED pattern that follows the previous LED pattern. The I-DE is now in the main menu and can be (re-)calibrated.

### Exit the main menu



When in "Calibration mode", push and hold the button for four seconds, then release. This LED pattern will be displayed for 2 seconds during this action.



The four seconds have been accepted when the LED turns off. A red or green LED will be displayed after the button is released.

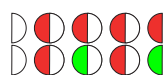

If the LED does not turn red or green, the I-DE will report an error using this LED pattern. The I-DE status is now "position lost" or "Error mode".

## 3 Operation

### 3.5.1 Reset I-DE position (Main menu 1)





If the I-DE has lost its position, it can be reset to the calibrated reset point. To do this, follow the steps below.

**NOTE:** The step-by-step plan below assumes that the I-DE is currently in «**main menu 1**» (see **Figure 7**).

If the I-DE is in «**Normal operation**» or «**Error mode**», «**Main menu 1**» can be accessed by pushing and holding the button for two seconds.

#### Reset I-DE position

---

-  The I-DE is in "Main menu 1".
  -  Push and hold the button for two seconds, then release. After 2 seconds, this LED pattern will be displayed.
  -  Turn the motor gearbox to the motor gearbox start position.
  -  Push and hold the button for two seconds, then release. After 2 seconds, this LED pattern will be displayed. The I-DE has been reset to the reset position.
  -  The I-DE will return to "Main menu 1".
-

# 3 Operation

## 3.5.2 Calibrate I-DE (Main menu 2)

The I-DE can be calibrated with a start, end and reset position. To do this, follow the steps below.

If one of the limit switches is connected to the reset input of the I-DE (see section 2.4), the reset position will be saved automatically. The position is saved during the calibration of the I-DE, when the limit switch in question is activated. The limit switch can be either that in the start position, or that in the end position. If the reset input is not used, the start position is automatically saved as the reset position.

As standard, the stroke of the I-DE corresponds to the stroke of the GW motor gearbox. If a higher degree of precision is required over a small part of the GW motor gearbox's stroke, the I-DE can be calibrated to that specific part of the stroke only. The I-DE furthermore allows the reset position to be configured at any random point in the GW motor gearbox's stroke.

For further information on these options, please contact De Gier ([sales@degierdrivesystems.com](mailto:sales@degierdrivesystems.com)).

**NOTE:** The step-by-step plan below assumes that the I-DE is currently in «main menu 1» (see Figure 7).

If the I-DE is in «Normal operation» or «Error mode», «Main menu 1» can be accessed by pushing and holding the button for two seconds.

### Calibrate I-DE

---



The I-DE is in "Main menu 1".



Push and hold the button for less than one second. This LED pattern will be displayed. The I-DE is in "Main menu 2"



Push and hold the button for two seconds, then release. After 2 seconds, this LED pattern will be displayed.



The I-DE is now in "Submenu 2A".

Run the motor gearbox to the start position (zero position).



Push and hold the button for two seconds, then release. After 2 seconds, this LED pattern will be displayed.



The I-DE is now in "Submenu 2B".

Run the motor gearbox to the end position.



Push and hold the button for two seconds, then release. After 2 seconds, this LED pattern will be displayed.



The I-DE is now calibrated and will output 0 mA, 4 mA or 20 mA, depending on the selected settings. The I-DE is in "Main menu 2"

---

# 3 Operation

## 3.5.3 Adjusting the I-DE current range (Main menu 3)

The current range of the I-DE is adjustable, with the user able to choose between a range of 0-20 mA and 4-20 mA. To do this, follow the steps below.

**NOTE:** The step-by-step plan below assumes that the I-DE is currently in "main menu 1" (see **Figure 7**).

If the I-DE is in "Normal operation" or "Error mode", "Main menu 1" can be accessed by pushing and holding the button for two seconds.

### Adjust I-DE current range

---



The I-DE is in "Main menu 1".



Push and hold the button for less than one second. This LED pattern will be displayed. The I-DE is in "Main menu 2"



Push and hold the button for less than one second. This LED pattern will be displayed. The I-DE is in "Main menu 3"



Push and hold the button for two seconds, then release. After 2 seconds, this LED pattern will be displayed.

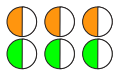

The I-DE is now in "Submenu 3A". (If "4 - 20 mA" has been selected).  
Or, the I-DE is now in "Submenu 3B". (If "0 - 20 mA" has been selected)

Push and hold the button for less than one second to change the selection (submenu); the LED pattern (see above) will change.



Push and hold the button for two seconds, then release. After 2 seconds, this LED pattern will be displayed.



The selection has been saved and the appropriate current will be output.  
The I-DE is in "Main menu 3"

---

# 3 Operation

## 3.5.4 Set I-DE current output start position (Main menu 4)

It is possible to configure the position at which the I-DE starts to output a current. Users can choose from 2 options:  
option 1: the start position at 0 mA or 4 mA

option 2: the start position at 20 mA

To do this, follow the steps below.

**NOTE:** The step-by-step plan below assumes that the I-DE is currently in «main menu 1» (see Figure 7).

If the I-DE is in «Normal operation» or «Error mode», «Main menu 1» can be accessed by pushing and holding the button for two seconds.

### Set I-DE current output start position

---



The I-DE is in "Main menu 1".



Push and hold the button for less than one second. This LED pattern will be displayed. The I-DE is in «Main menu 2



Push and hold the button for less than one second. This LED pattern will be displayed. The I-DE is in «Main menu 3»



Push and hold the button for less than one second. This LED pattern will be displayed. The I-DE is in «Main menu 4»



Push and hold the button for two seconds, then release. After 2 seconds, this LED pattern will be displayed

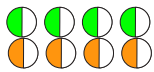

The I-DE is now in «Submenu 4A». (If «0 or 4 mA» has been selected).  
Or, the I-DE is now in «Submenu 4B». (If «20 mA» has been selected)

Push and hold the button for less than one second to change the selection (submenu): the LED pattern (see above) will change.



Push and hold the button for two seconds, then release. After 2 seconds, this LED pattern will be displayed



The selection has been saved and the appropriate current will be output.  
The I-DE is in «Main menu 4»

---

# 3 Operation

## 3.5.5 I-DE A/B/Z mode configuration (Main menu 5)











The I-DE permits users to configure the way in which the A/B/Z outputs are controlled. Users can select either HTL, TTL or Open Collector. To do this, follow the steps below.

**NOTE:** The step-by-step plan below assumes that the I-DE is currently in «main menu 1» (see Figure 7).

If the I-DE is in «Normal operation» or «Error mode», «Main menu 1» can be accessed by pushing and holding the button for two seconds.

### I-DE A/B/Z mode configuration

---

-  The I-DE is in "Main menu 1".
  -  Push and hold the button for less than one second. This LED pattern will be displayed. The I-DE is in "Main menu 2"
  -  Push and hold the button for less than one second. This LED pattern will be displayed. The I-DE is in "Main menu 3"
  -  Push and hold the button for less than one second. This LED pattern will be displayed. The I-DE is in "Main menu 4"
  -  Push and hold the button for less than one second. This LED pattern will be displayed. The I-DE is in "Main menu 5"
  -  Push and hold the button for two seconds, then release. After 2 seconds, this LED pattern will be displayed.
  
  -  The I-DE is now in "Submenu 5A". (If "Open Collector" has been selected).
  -  Or, the I-DE is now in "Submenu 5B". (If "HTL" has been selected).
  -  Or, the I-DE is now in "Submenu 5C". (If "TTL" has been selected).
  
  - Push and hold the button for less than one second to change the selection (submenu); the LED pattern (see above) will change.
  -  Push and hold the button for two seconds, then release. After 2 seconds, this LED pattern will be displayed.
  -  The selection has now been saved. The A/B/Z signals will now be controlled in the required manner. The I-DE is in "Main menu 5"
- 

**NOTE:** Improper use of this function may cause damage to external equipment

# 4 Technical Specifications

## 3.6 Power failure

In the event of a power failure, the last known position of the motor gearbox at that time will be stored in the memory of the I-DE. When the power is restored, the I-DE will then check whether the motor gearbox was turned during the power failure. If the motor was turned prior to the power being restored to the I-DE, the I-DE will report the error «position lost».

## 3.7 Restoring the factory settings

The I-DE is in “Normal operation”, “Error mode” or “Calibration mode”. All versions of the LED patterns are possible. (See section 3.1)



Push and hold the button for ten seconds. This LED pattern will be displayed. The I-DE has now been reset to factory settings

## 4 Technical Specifications

Power Supply	Maximum power consumption	Digital A/B/Z output resolution	Current output resolution	Dimensions
24 V AC/DC	30 mA (without 0 - 20 mA output current)	7 bit	8 bit (maximum 5000 steps)	52 x 30 x 20 (l x w x h)

